

*Cooper*

**ATKINS**®

*Accuracy to the Highest Degree*



# INDUSTRIAL CATALOG

HVAC/R • Facilities • OEM



# Cooper-Atkins Corporation

*A customer-centric technology leader in monitoring solutions for the global Foodservice, Healthcare and Industrial markets.*



*Carol P. Wallace has been the President and CEO of Cooper-Atkins Corporation since 1994 and is recognized by the WBENC for leading a successful and thriving woman-owned corporation. The WBENC is the largest third-party certifier of businesses owned, controlled, and operated by women in the U.S.*



## Company History

The inventor of the first bi-metal oven thermometer, David G. Cooper, founded *The Cooper Oven Thermometer Company* in 1885. During the 1960s, the company developed three cooking product lines and with the acquisition of *The Croydon Thermometer Company* expanded into weather instrumentation. Two separate marketing groups were established for the consumer and industrial markets to advance these new product lines.

In 1984, the industrial division of *Electromedics (Electro-Therm)* was purchased, immediately launching Cooper into the digital thermometer business. The company officially became *Cooper Instrument Corporation* strengthening its presence in the HVAC/R, OEM and industrial markets.

In 2001, after acquiring *Atkins Technical* (a leader in thermocouple instrument technology), the company became known as *Cooper-Atkins Corporation*.

In 2003 the corporation acquired *KTG, Inc.*, a developer of wireless enterprise solutions for temperature monitoring and food safety.

## Company Overview

Since its establishment in 1885, Cooper-Atkins has built a 130-year, rock-solid reputation providing quality environmental monitoring solutions to top brands such as Mars Chocolate, Subway, Pepsico, Quaker Oats, Nestle, and many, many more. Our proven track record speaks for itself.

In today's rapidly changing world, we continue to expand our technological capabilities to support and protect brand integrity by providing the right tools that ensure consistent food quality and safety across all our business units.

## Contents

The Industrial Market - a Changing Landscape .....	3
NotifEye™ Cloud-based Wireless Monitoring .....	4
NotifEye™ Grower's Kit.....	5
EnviroTrak™ Wireless Monitoring .....	6
Blue2™ Bluetooth Temperature Transmission .....	7
HACCP Manager™ Solo .....	8
HACCP Manager™ Enterprise.....	9
HACCP Manager™ Mobile.....	9
TravAlert™ Data Loggers .....	10
Thermistor Instruments .....	11-12
Thermistor Probes.....	13
Dual Input Thermocouple Kits.....	14
EconoTemp™ Thermocouple Instruments .....	15
AquaTuff™ Thermocouple Instruments.....	16-17
Type K Thermocouple Probes.....	18-19
Digital Panel Thermometers.....	20-21
Vapor Tension Panel Thermometers .....	22
Bi-metal Thermometers.....	23
Digital Pocket Test Thermometers .....	24-25
Val Cup™ and Probe Wipes.....	25
Infrared Thermometers.....	26-27
Refrigerator/Freezer Thermometers.....	28
Hot-holding Thermometers.....	28
Digital/Wall Thermometers .....	29-30
Timers.....	31

McDonald's awarded  
Cooper-Atkins the  
"Global Supplier  
of the Year 2015"



# The Industrial Market - a Changing Landscape

Emerging wireless and digital technology is at the forefront of indoor and environmental temperature monitoring. As an industry leader, we continue to provide state-of-the-art technology to help meet our customers' needs.

Facilities are becoming "smart" and automated and we recognize the need to: integrate into current Building Automation & Control Networks (BACnet); offer real-time monitoring of labs and indoor air-quality; and provide wireless monitoring and alerting capabilities to satisfy government regulatory compliance for food processing facilities! Below are just some of the niche markets that we serve that are expanding under the industrial business umbrella.

## Food Processing



During processing, temperature monitoring and control of pathogens are both critical to ensuring a food-safe environment. Automating both temperatures and humidity monitoring will increase efficiency and allow detailed reporting and compliance with current HARPC/HACCP plans.

## Laboratory



Monitor the temperature and humidity level in your clean room with speed and accuracy. Scientists and technicians rely on Cooper-Atkins products that are traceable to the standards of NIST and are durable, waterproof and meet recognized industry certifications.

## HVAC/R



Technicians and contractors trust our products in critical IAQ applications when measuring temperatures on pipe surfaces; air flow in rooms and duct work; or analyzing system pressures in heating/ air-conditioning. The reliability and scalability of products increases field efficiency.

## Agriculture



With the organic and medicinal industries on the upsurge, there is a need to control the temperature & humidity of greenhouses and holding silos. Our line of specialty products are designed for the agriculture and horticulture markets. Versatile and scalable, they also conform to current government compliances and regulations.

## Facilities Maintenance



Quality tools for the Maintenance Engineer range from simple Bi-metal thermometers to wireless temperature monitoring enterprise systems. We are committed to providing the right measurement/testing instrument, tool or test equipment for the job.

## Refrigeration



Quality tools for the refrigeration technician range from simple Bi-metal and vapor tension thermometers to state-of-the-art wireless monitoring systems. Used for measuring temperatures on pipe surfaces, or analyzing system pressures in refrigeration equipment, the durability, reliability and expandability of our products have been time tested

## Warehousing



Maintaining specific temperature ranges is important in all areas of a controlled environment. Monitoring of temperature and humidity in refrigerators, walk-ins, freezers, distribution and shipping areas is an important part of the cold chain management. Accurate temperature profiling over prolonged periods ensures accurate storage temperatures for your products.

## Logistics



Monitor product storage temperatures during transport to comply with "Farm-to-Fork" traceability. Analyze data to ensure product temperatures are not compromised.





The NotifEye™ cloud-based temperature monitoring and notification system is a low-cost wireless solution. System data is accessible on-line 24/7, while out-of-range notifications are sent in real-time as e-mail and text alerts. Sensors pass information wirelessly to the software database which collects and records data 24/7.

Each sensor is battery operated and monitors against preset conditions that are user-defined within the NotifEye application.

To View the online system and Live Data!

Log Into: [monitoring.notifeyewireless.com](http://monitoring.notifeyewireless.com)

User Name: **notifeye**

Password: **notifeye**



## How It Works

Wireless Sensors Send Data via Gateways to the NotifEye™ System and Send Out Instant Email and Text Alerts



### Gateway Kit #15906 Includes:

- (4) Temp Sensors #15200
- (4) Batteries
- (1) Gateway #15505
- (1) Buffer Cable
- (1) Ethernet Cable
- 1-Year Web Hosting\*



### Gateway Kit #15907 Includes:

- (2) Temp Sensors #15200
- (2) Batteries
- (1) Gateway #15505
- (1) Buffer Cable
- (1) Ethernet Cable
- 1-Year Web Hosting\*



\* Renewal fee each additional year thereafter

### Multiple Applications:

- Refrigerator/Freezers
- Walk-ins/Reach-ins
- Prep Areas
- Steam Tables
- Open Air Cases
- Hot-holding Cabinets
- Salad/Deli Bars



<b>#15200 Temperature Sensor*</b>
Temperature Range: -25° to 180°F (-32° to 82°C)
Accuracy: ±1.2°F (±0.7°C)
<b>#15220 Humidity Sensor</b>
Relative Humidity Range: 0-90% RH
Ambient Operating Range: -4° to 140°F (-20° to 60°C)
Accuracy: ±2% (10-90% RH)
<b>#15230 Contact Sensor</b>
Magnet operation gap up to 0.75"
<b>#15201-01 Immersion Probe</b>
Temperature Range: -25° to 180°F (-20° to -60°C)
Accuracy: ±1.2°F (±0.7°C)
Probe Diameter: 0.25" (6.4 mm)
<b>#15505 Gateway Specifications</b>
<ul style="list-style-type: none"> <li>• Operating range: 32° to 140°F (5° to 50°C), up to 90% RH</li> <li>• 200 Monitoring Points = 30 Days of Storage</li> </ul>
<b>#15506 Repeater</b>
<ul style="list-style-type: none"> <li>• Extends sensor range, transmits up to 4 miles (open field range)</li> </ul>
<b>General Specifications</b>
Sensor Range: 2500 ft (typical interior range of 500 ft)
Probe Lead Length: 6 ft. (1.82 m)*
Battery Life: 2.5 - 3 years
1-year warranty

\*Temperature sensors available with longer probe leads: 15200-10 - 10 ft. (3.05 m) and 15200-30 - 30 ft. (9.14 m)



Cloud-based Monitoring and Notification System

Install this easy-to-use system to wirelessly monitor soil and air temperatures to ensure environmental conditions are optimal for planting. This kit is ideal for monitoring both temperature and humidity levels in a greenhouse - two key factors for successful germination and growing quality crops.

Analyze the system data to make adjustments and save energy by heating only until optimal growing can be sustained. Also, as an exception-based system, alerts can be sent when preset temperature and humidity limits are exceeded.

With the organic and medicinal industries on the upsurge, there is a need to control the temperature & humidity of greenhouses and holding silos. Our line of specialty products are versatile and scalable and conform to current government compliances and regulations.

Gateway #15505



Immersion Probe #15201-01



Temperature Sensors #15200-10



Humidity Sensor #15220

**Growers Kit #15910 Includes:**

- (2) Temperature Sensor #15200-10
- (1) Humidity Sensor #15220
- (1) Immersion Probe #15201-01
- (1) Gateway #15505
- 1-year Hosting (included)\*



\*Renewal fee each additional year thereafter

**Alert Features:**

- On-screen Alerts and Notifications sent via Email and SMS Text
- Permission-based Access Control and Reporting
- List of Recent Alerts for Individual Sensors

**Sensor Features:**

- Unlimited Number of Networks, Sensors, Gateways and Users Supported
- Sensor Mapping Tool (Visual Placement)
- Data Reports and Sensor History Storage
- Visual Charts and Exports

## How It Works

Wireless Temperature and Humidity Sensors Send Data via the Gateway to the NotifEye™ System. Instant Alerts are sent out when preset limits are exceeded.





## EnviroTrak™

Wireless Monitoring To Protect Your Brand

Proper receiving, storing, holding, and monitoring of temperatures is vital in preventing bacterial growth in foods. The accurate reporting and logging of data is now a standard measure to ensure HACCP compliance. EnviroTrak offers 24/7 monitoring of temperature, humidity, door open/close, etc., eliminating the need for labor-intensive manual temperature logs.

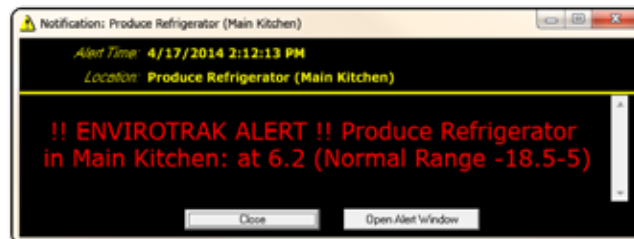

### Hardware

- Scalable to any size building or campus
- Multiple locations
- Waterproof housing accessories
- Automatic battery backup
- Available in 900 MHz and Wi-Fi
- 900 MHz and Wi-Fi hardware can coexist and integrate with outside wireless communications
- All EnviroTrak probes function with 900 MHz and 802.11 Wi-Fi transmitters

### Software

- View anywhere capability online
- Real-time & historical data
- Instant alerts with escalation levels
- Documentation of corrective actions
- Customized views & reports
- Easy to use navigation
- Enhanced security access controls
- Reports for trend analysis
- Compatible with multiple browsers

### Service and Support

- Requires minimal infrastructure
- Automated database backups
- 24/7 live emergency support
- Unlimited web-based training
- Software upgrades
- Mapping Services
- Turnkey Solutions
- IQ/OQ Services



### EZ Link\*

Respond to EnviroTrak alarms via your mobile device 24/7.

*\*compatible with current generation smartphones and tablets*



**LEARN MORE!**





The Blue2 instrument transmits temperatures wirelessly to your mobile device via Bluetooth Low Energy. The instrument can utilize any interchangeable Type-K temperature probe making it versatile for insertion, air or surface temperature measurement. The instrument works with a smart device and the HACCP Manager Mobile App. The data can also be integrated into existing third party applications from information provided by API documentation.

### 92010-K Kit Includes:

- 20100-K Blue 2 Instrument
- 51337-K DuraNeedle
- Direct Connect Probe



### Interchangeable Probes

Can be used with any Type K probe

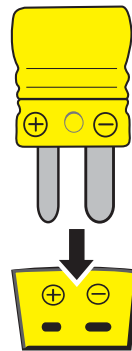

### 51337-K Duraneedle Probe

Utilizes unique screw-lock

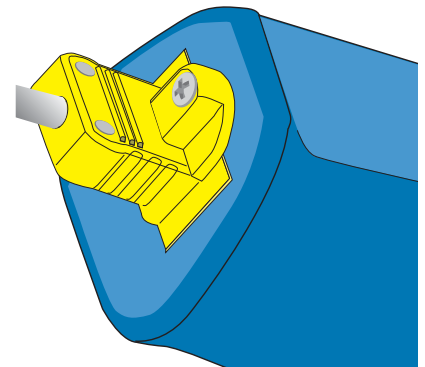

The Blue2 instrument works with the HACCP Manager Mobile app and 3rd party apps for increased versatility.



Watch the Video!

### Specifications

#### #20100-K Blue2 Instrument

Temperature Range: -40° to 999°F (-40° to 537°C)
Ambient Operating Range: 32° to 122°F (0° to 50°C)
Resolution: 0.1°
Accuracy: ±0.5°F with ambient temperatures between 68° to 86°F, add ±0.1°F per degree outside of this ambient range
RF Range: 100 feet (30.5 m), line-of-sight
Bluetooth Low Energy
Power: Replaceable 3V Lithium cell battery (CR123A) (Included)
Battery Life: 500 hours
ABS plastic housing with antimicrobial additive
IPX7 waterproof rated
Traceable to NIST standards
5-year Warranty



*Note: EMC Compliance: The Blue2 instrument may record temperature measurements beyond the stated accuracy when exposed to radio frequency disturbances between 250Mhz and 1000Mhz with a field strength in excess of 3.0V/m. This deviation is temporary and the Blue2 will recover when the disturbance is removed.*

#### #50337-K DuraNeedle Probe

Temperature Range: -100° to 500°F (-73° to 260°C)
Accuracy: ±1°F
Response Time: 1 second in liquid
Probe Length: 4" (102 mm)
1-year Warranty



The planning and training involved in a paper-based HACCP food safety program is laborious, costly and can be a burden to your business. The Handheld is a portable data-collecting instrument designed to simplify the gathering of temperatures, manage standard checklist processes and document corrective actions.

Incorporating the HACCP Manager into a safety program will help to eliminate the laborious planning and training involved in a traditional HACCP/HARPC/HACCP food safety programs. In addition to time and money savings, it will increase consumer confidence and ultimately improve the overall customer experience.

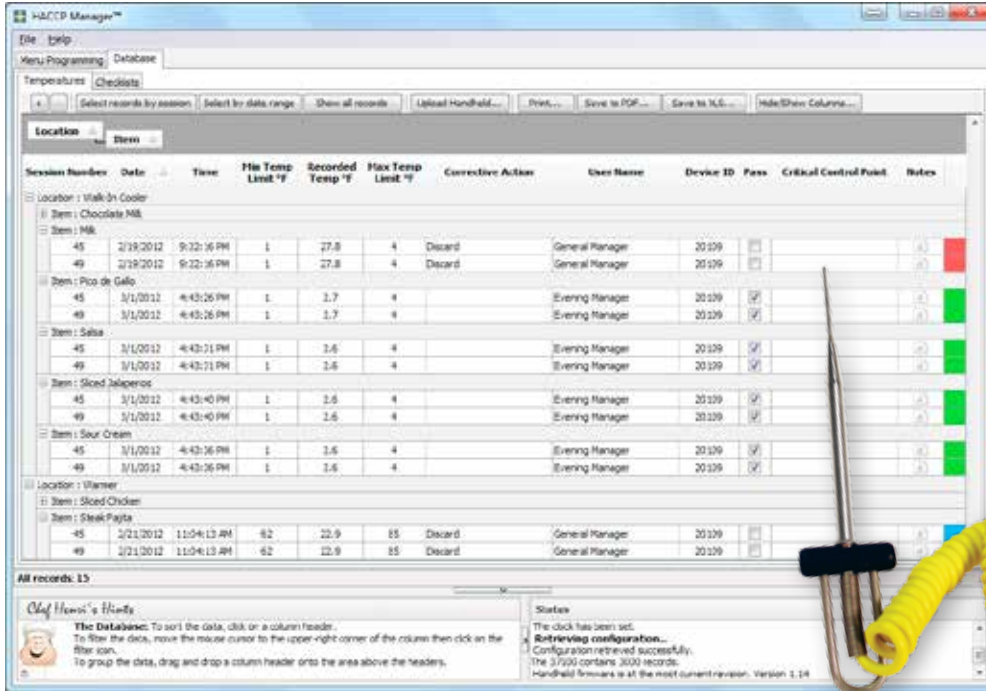

## 93710 HACCP Manager™ Solo Kit

- 37100 Handheld
- 50209-K MicroNeedle Probe
- 9382 Battery Charger
- 9383 USB Cable
- 9384 Software USB



**WATCH THE VIDEO!**



### 37100 Specifications

Temperature Range: -99.9° to 999.9°F (-73.2° to 537.7°C)
Accuracy: ±1°F (±0.5°C)
Resolution: 0.1°
Stores up to 3,000 temperatures and 300 menu items
Stores 1500 checklist records (150 questions)
Water resistant
ABS Plastic with protective rubber boot
Accepts all Type K thermocouple probes
Traceable to NIST standards
Rechargeable lithium ion battery
5-year warranty

Works as a standalone system with software residing on a local PC. Not Mac Compatible.





This state-of-the-art system allows a HARPC/HACCP plan, that complies with local health codes, to be custom built for any food business. Addressing health safety concerns is vital in today's foodservice industry and is, in some cases, government mandated.

The HACCP Manager Enterprise application is used to build menus and checklists, which are then downloaded to any of the data collection devices (handheld or Mobile App).

Critical data is sent to our hosted server via a USB or Wi-Fi connection.



Specifications
Temperature Range: -99.9° to 999.9°F (-73.2° to 537.7°C)
Accuracy: ±1°F (±0.5°C)
Stores up to 3,000 temperatures and 300 menu items
Stores 1,500 checklist records (150 questions)
Water resistant
ABS Plastic with protective rubber boot
Accepts all Type K thermocouple probes
Traceable to NIST standards
Rechargeable lithium ion battery
5-year warranty

## 93755

### HACCP Manager™ Enterprise Kit

- 37500 WiFi-enabled Handheld
- 50209-K MicroNeedle Probe
- 9382 Battery Charger
- 9383 USB Cable

## 93751

### HACCP Manager™ Enterprise Kit

- 37200 Handheld
- 50209-K MicroNeedle Probe
- 9382 Battery Charger
- 9383 USB Cable

### Hosting

HACCP Manager Enterprise is a hosted software solution. It reduces entry related start-up costs and reduces the reliance on IT for maintenance and installation.

### Type K Probes

Interchangeable Type K probes, enable the HACCP Manager to be used to check temperatures of various food types and equipment throughout your facility.

### Kits & Accessories

The two main kits differ in the Handhelds and how they transfer information. This 37200 Handheld connects to a Network-based computer bridge via USB cable. This allows communication with the software database. The 37500 Handheld has a built-in WiFi module to allow wireless data transfer. This model communicates primarily via Wi-Fi. It operates via the USB cable, in the event a Wi-Fi connection cannot be established, or for firmware updates.

# HACCP Manager™ Mobile



To reduce managing reams of paper logs that are laborious to analyze, the HACCP Manager Mobile App, used with the Blue2 instrument, collects and stores that information via your smart device. This data can then be uploaded to the cloud software on the fly, significantly saving time and streamlining the process of specific HACCP requirements.

The HACCP Manager Mobile App is downloaded to your smart device and works in conjunction with the Blue2 instrument.

The Blue2 is available as part of a kit that includes a Type K DuraNeedle Direct Connect probe. The Blue2 instrument transmits temperatures wirelessly to your mobile device via Bluetooth Low Energy. The App provides the capability to be used in multiple languages to increase versatility.

- Switch menus and checklists on the fly
- Works with the Blue2 device
- Multiple language support
- Can be used in conjunction with Enterprise handhelds





## TravAlert™

TravAlert™ is most commonly used for monitoring storage temperatures during transportation and provides highly accurate data for use in the foodservice and industrial markets. It can also be used to monitor and record temperatures of stationary refrigeration units or hot-holding cabinets.

The self-powered Data Logger is a time and temperature, PC interfacing device that can record up to 2,048 temperatures (in intervals from 1 minute to 4 hours) and is splash, dirt and impact resistant.

### 2300

#### TravAlert™ Data Logger Kit

- 9387 Data Logger (5)
- 9364 i-Button Reader Cable (2)
- 9365 USB Adapter (2)
- 9386 Software CD (2)



Features
Unique user-defined session identity
Go/No-Go Icon for immediate visual (based on user-defined parameters)
All readings for session shown in graph and tabular format
Printable to PDF at destination
Quick session summary display

### GL100

#### Water-resistant, Mini Data Loggers

Data logger tag monitors both time and temperature

- Two (2) mini data loggers
- Two (2) mounts
- Reader and software
- 1-year warranty

Not Mac Compatible.



Specifications
Temperature Range: -40° to 185°F (-40° to 85°C)
Accuracy: ±2°F (±1°C) from -22° to 176°F (-30° to 70°C)
Resolution: 1°F (0.5°C) increments
Recording Intervals: 1-255 user-programmable intervals up to 2,048 readings
Tag: ABS plastic tag with stainless steel button
Water resistant
Reprogrammable for multiple uses
Battery: Lithium
Warranty: 1 year

### TransTrak™ Reports & Sessions

Temperatures exceeding pre-programmed limits during transit can be easily evaluated by a unique Transport Session report.

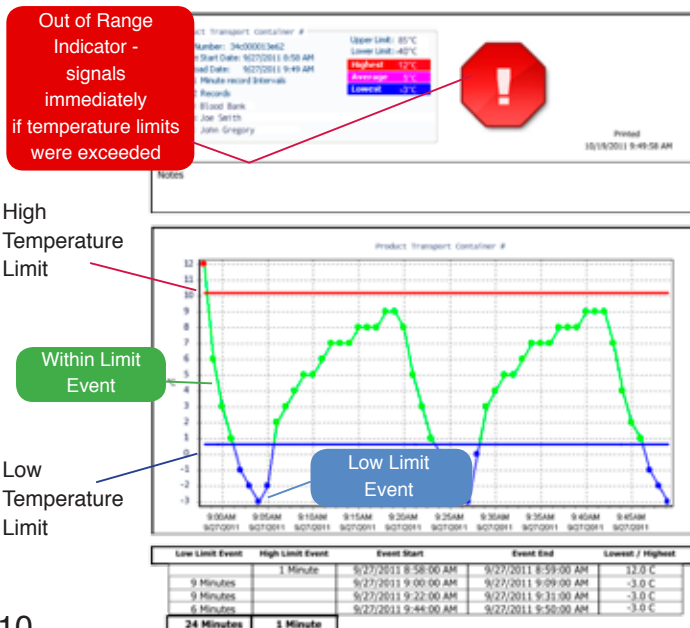



# Thermistor Instruments

## SH66A-E 3-Zone Temperature Instrument

For applications when multiple temperature measurements are needed, this is the instrument to use. Simultaneously measure suction and liquid line temperatures, as well as temperatures across condensing coils, evaporator coils and ambient temperatures. View temperature differential between zones 1 and 2 and review min/max temperatures from all three zones. Features include: a backlit display for dark environments; a sealed keypad which protects the instrument from spills and dust; and a battery eliminator jack. (*Specifications are on Page 12.*)

### SH66A-E:

- 1075 General Purpose Puncture Probe
- 2010 Air Probe
- 4011 Pipe Strap Probe

### \*SH66A-E-032:

- 1075 General Purpose Puncture Probe
- 2010 Air Probe
- 4011 Pipe Strap Probe
- Certificate of calibration traceable to NIST standards



## SRH77A-E 3-Zone Temperature/Humidity Instrument

When temperature and relative humidity measurements are critical, the SRH77A-E is the expert's choice. View temperature differential, %RH and wet-bulb. You will find this to be an accurate and fast service tool. Features include: a backlit display for dark environments; sealed keypad which protects the instrument from spills and dust; and a battery eliminator jack. The bright blue, durable carrying case makes this tool easy to find when on location or in the back of a service truck. (*Specifications are on Page 12*)

### SRH77A-E:

- 1075 General Purpose Puncture Probe
- 4011 Pipe Strap Probe
- 5028 Slim Humidity Probe

### \*SRH77A-E-032:

- 1075 General Purpose Puncture Probe
- 4011 Pipe Strap Probe
- 5028 Slim Humidity Probe
- Certificate of calibration traceable to NIST standards



Cooper-ATKINS <sup>®</sup> Accuracy to the Highest Degree		CERTIFICATE OF CALIBRATION & REPORT	
Instrument Identification			
Company: Customer A	Instrument ID #: 11413018		
Description: Temperature Tester	Model: TM99A		
Mfr: Cooper-Atkins Corporation	Serial #: 11413018		
Accuracy: $\pm 0.3^{\circ}\text{F}$ / $\pm 0.2^{\circ}\text{C}$ or $\pm 0.5\%$ of reading whichever is greater			
Emissivity: N/A			
Calibration Information			
Technician: Employee A	Date: January 14, 2013		
Condition As Found: NEW	Temperature: 74.7		
Condition As Left: In Tolerance	Humidity: 25%		
Procedure: PS09-697			

\* Cooper-Atkins thermistor instruments are calibrated to temperature, electrical and/or resistance standards maintained by the company. The measurement results obtained through these standards are traceable to the U.S. Department of Commerce, National Institute of Standards and Technology (NIST). Used in HVAC/R applications where IAQ (Indoor Air Quality) and accuracy of measurements are critical to healthy environment indoor conditions and product safety such as hospitals, labs, schools, refrigeration of products and energy consumption.

## 4005i

### Cordless Pipe Clamp Temperature Instrument

Includes 2.5" (64 mm) Retractable General Purpose Puncture Probe. Measure temperature of pipes up to 1.375" (35 mm) diameter.

- Single-handed Use
- Spring-loaded Probe to Ensure Repeatability
- Auto shut-off After 5 Minutes of Non-use
- Mode Button: Min, Max and Hold
- Nylon, Belt-pouch (included)





## TM99A Series

### Thermistor Temperature Instrument

For applications where only one temperature is needed. It features Min/Max Memory, Hold, Auto-shutoff and an LCD backlight for dark environments.

#### TM99A:

- 1075 General Purpose Puncture Probe
- 9339 Soft, Carrying/Storage Pouch

#### TM99A-032:

- 1075 General Purpose Puncture Probe
- 9339 Soft, Carrying/Storage Pouch
- Certificate of calibration traceable to NIST standards

#### TM99A-V:

- 1050 Blunt-tip Veterinary Probe
- 9339 Soft, Carrying/Storage Pouch

TM99A



	SH66A/SH66A-E-032	SRH77A/SRH77A-E-032	TM99A/TM99A-032	4005i
<b>Temperature Range:</b>	-40° to 300°F (-40° to 150°C)	-40° to 300°F (-40° to 150°C)	-40° to 302°F (-40° to 150°C)	-20° to 300°F (-29° to 149°C)
<b>Accuracy:</b>	±0.3°F (0.2°C) OR ±0.5% Rdg. whichever is greater	±0.3°F (0.2°C) OR ±0.5% Rdg. whichever is greater	±0.3°F (0.2°C) OR ±0.5% Rdg. whichever is greater	Clamp: ±3°F (2°C) from 14° to 212°F (-10° to 100°C), Probe: ±3°F (2°C)
<b>Humidity Range:</b>	-	10 to 95% RH	-	-
<b>Humidity Accuracy:</b>	-	±2% from 20 to 80% RH ±3% below 20% and above 80% RH	-	-
<b>Resolution:</b>	0.1°	0.1° 1% RH	0.1°	0.1°
<b>Display - LCD:</b>	2" x .875" (51 mm x 22 mm)	2" x .875" (51 mm x 22 mm)	.5" (13 mm)	.25" x .875" (6 mm x 22 mm)
<b>Backlight:</b>	Yes	Yes	Yes	No
<b>Min / Max:</b>	Yes	Yes	Yes	Yes
<b>Hold:</b>	No	No	Yes	Yes
<b>Ambient Operating Range:</b>	0° to 130°F (-18° to 54°C) Up to 90% RH non-condensing	0° to 130°F (-18° to 54°C) Up to 90% RH non-condensing	32° to 122°F (0° to 50°C)	0° to 120°F Up to 90% RH non-condensing
<b>Case Material:</b>	Polyethylene	Polyethylene	ABS	Plastic
<b>Weight:</b>	1 lb 5 oz (595 g)	1 lb 5 oz (595 g)	5 oz (142 g)	5 oz (142 g)
<b>Power:</b>	(1) 9V Alkaline	(1) 9V Alkaline	(2) AAA Alkaline	(1) 1.5V LR44
<b>Auto Shut-off:</b>	Yes (after 15 mins)	Yes (after 15 mins)	Yes (after 5 mins)	Yes (after 5 mins)
<b>Battery Life:</b>	90 hours	90 hours	1800 hours	90 hours
<b>Regulatory Listings:</b>	CE RoHS	CE RoHS	CE RoHS	
<b>Warranty:</b>	5 year instrument/1 year probe	5 year instrument/1 year probe	5 year instrument/1 year probe	1 year





## Needle Probes

All Thermistor Temperature Probes are interchangeable with all Cooper-Atkins Thermistor Instruments.

	1013	1014	1030	1050	1052	1075	1078	6000
<b>Description:</b>	Meat-Packing Puncture Probe	17" Puncture Probe	Screw-in Puncture Probe	Blunt-tip Veterinary Probe	Needle Probe	General Purpose Puncture Probe	7" Puncture Probe	18" Flexible Thermistor Probe
<b>Temperature Range:</b>	-40° to 300°F (-40° to 149°C)	-40° to 300°F (-40° to 149°C)	-40° to 300°F (-40° to 149°C)	-40° to 300°F (-40° to 149°C)	-40° to 300°F (-40° to 149°C)	-40° to 300°F (-40° to 149°C)	-40° to 300°F (-40° to 149°C)	-25° to 200°F (-40° to 93°C)
<b>Max Tip Temperature:</b>	300°F (149°C)	300°F (149°C)	300°F (149°C)	300°F (149°C)	300°F (149°C)	300°F (149°C)	300°F (149°C)	200°F (93°C)
<b>Max Cord Temperature:</b>	200°F (93°C)	200°F (93°C)	400°F (204°C)	200°F (93°C)	200°F (93°C)	200°F (93°C)	200°F (93°C)	200°F (93°C)
<b>Response Time (liquid):</b>	6 seconds	100 seconds	20 seconds	6 seconds	4 seconds	6 seconds	6 seconds	50 seconds
<b>Shaft Length:</b>	3.75" (95 mm)	17" (430 mm)	2.5" (64 mm)	3.5" (89 mm)	2.9" (74 mm)	3.75" (95 mm)	7" (178 mm)	18" (457 mm)
<b>Shaft Diameter:</b>	0.140" (4 mm)	0.25" (6 mm)	0.165" (4 mm)	0.125" (3 mm)	0.041" (1 mm)	0.146" (3.6 mm)	0.140" (4 mm)	0.156" (4 mm)
<b>Cord Length:</b>	6' (1.8 m) polyurethane (uncoiled)	6' (1.8 m) polyurethane (uncoiled)	6' (1.8 m) polyurethane (straight)	6' (1.8 m) polyurethane (uncoiled)	6' (1.8 m) polyurethane (uncoiled)	6' (1.8 m) polyurethane (uncoiled)	6' (1.8 m) polyurethane (uncoiled)	12' (3.7 m) PVC (straight)
<b>Warranty:</b>	1 year	1 year	1 year	1 year	1 year	1 year	1 year	1 year

**1013**  
Meat-Packing Puncture Probe



**1014**  
17" Puncture Probe with Heavy-Duty Cord



**1030**  
Screw-in Probe with 1/8" NPT Fitting



**1050**  
Blunt-Tip Veterinary Probe



**1052**  
Needle Probe (use with Pete's Plugs)



**1075**  
General Purpose Puncture Probe



**1078**  
7" Puncture Probe



## Surface Probes

## Air Probes

	3010	4005	4011	4040	7010	2007	2010	5005	5028
<b>Description:</b>	Plastic Shaft Probe	Pipe Clamp Probe	Pipe Strap Probe	Fast Response Surface Probe	Air/Surface Probe	Blunt Tip Veterinary Probe	Air Probe	Air Probe	Slim Temp/Humidity Probe
<b>Temperature Range:</b>	-40° to 200°F (-40° to 93°C)	-14° to 212°F (-10° to 100°C)	-25° to 212°F (-32° to 100°C)	-40° to 212°F (-40° to 100°C)	-40° to 200°F (-40° to 93°C)	-40° to 300°F (-40° to 149°C)	-40° to 200°F (-40° to 93°C)	-40° to 300°F (-40° to 149°C)	0° to 150°F (-18° to 66°C)
<b>Humidity Range:</b>	-	-	-	-	-	-	-	-	10 to 95% RH
<b>Max Tip Temperature:</b>	200°F (93°C)	200°F (93°C)	212°F (100°C)	212°F (100°C)	200°F (93°C)	300°F (149°C)	200°F (93°C)	300°F (149°C)	150°F (66°C)
<b>Max Cord Temperature:</b>	200°F (93°C)	200°F (93°C)	200°F (93°C)	200°F (93°C)	200°F (93°C)	400°F (204°C)	200°F (93°C)	200°F (93°C)	200°F (93°C)
<b>Response Time:</b>	15 seconds	12 seconds	-	15 seconds	20 seconds	6 seconds	20 seconds	-	30 seconds
<b>Shaft Length:</b>	3" (76 mm)	-	-	3.5" (89 mm)	0.160" (4 mm)	4" (102 mm)	0.5" (13 mm)	4" (102 mm)	4.9" (125 mm)
<b>Shaft Dia.</b>	0.156" (4 mm)	-	-	0.310" (Tip) (8 mm)	0.5" (13 mm)	0.140" (4 mm)	0.160" (4 mm)	0.125" (3 mm)	0.25" (6 mm)
<b>Cord Length:</b>	6' (1.8 m) polyurethane (uncoiled)	10' (3 m) TPE (uncoiled)	12' (3.7 m) polyurethane (uncoiled)	6' (1.8 m) polyurethane (uncoiled)	6' (152 mm) PVC cord (straight)	10' (3.0 m) PTFE (straight)	12' (3.6 m) polyurethane (straight)	6' (1.8 m) polyurethane (uncoiled)	6' (1.8 m) PVC (uncoiled)
<b>Warranty:</b>	1 year	1 year	1 year	1 year	1 year	1 year	1 year	1 year	1 year



**4005**  
Pipe Clamp Probe (Maximum 1-3/8" Ø Pipe Clamp Opening)

**2007**  
Blunt Tip Veterinary Probe



**4011**  
Pipe Strap Probe (Strap, 11" Long x 1/2" Wide approx.)



**4040**  
Fast Response Surface Probe



**9010 10 ft./ 9015 50 ft. Extension Cable**



**2010**  
Air Probe



**5028**  
Slim Temp/Humidity Probe



# Dual Input Thermocouple Kits



The TD2000 is a dual-input, Type K thermocouple instrument designed to monitor two zones simultaneously. The TD2000 is ideal for monitoring in/out flow lines of cooling and heating units and displays Max temperature and Delta-T calculations. It includes a protective rubber boot and has a temperature range up to 2000°F. The TD2000-01 Kit includes two Bead Tip probes and a Needle probe (for internal measurement of liquids or solids). The TD2000-02 Kit includes two 54011-K Pipe Strap Surface probes and a soft carrying pouch.



	TD2000-01	TD2000-02
<b>Temperature Range:</b>	-58° to 2000°F (-50° to 1093°C)	-58° to 2000°F (-50° to 1093°C)
<b>Accuracy:</b>	±4°F (2°C) from -58° to 32°F (-50° to 0°C) ±0.3% +2°F (1°C) from 32° to 2000°F (0°C to 1093°C)	±4°F (2°C) from -58° to 32°F (-50° to 0°C) ±0.3% +2°F (1°C) from 32° to 2000°F (0°C to 1093°C)
<b>Resolution:</b>	1°	1°
<b>Housing:</b>	ABS	ABS
<b>Hold:</b>	Yes	Yes
<b>Backlight:</b>	No	No
<b>Waterproof:</b>	No	No
<b>Power:</b>	(1) 9V	(3) 1.5V AAA
<b>Battery Life:</b>	200 hours	200 hours
<b>Auto Off:</b>	10 min.	10 min.
<b>Weight:</b>	10.7 oz (303 g)	10.7 oz (303 g)
<b>Regulatory Listings:</b>	CE	CE
<b>Warranty:</b>	5-year Inst./ 1-year probe	5-year Inst./ 1-year probe

## TD2000-01 Dual Input Thermocouple Kit

- TD2000 Thermocouple Instrument
- (2) 6030MK Bead Tip Probes
- 31901-K Needle Probe

## TD2000-02 Dual Input Thermocouple Kit

- TD2000 Thermocouple Instrument
- (2) 54011-K Pipe Strap Surface Probes
- 14057 Soft Pouch







The **EconoTemp™** series employs state-of-the-art technology in economy thermocouple instruments. Designed with a powerful microprocessor and a unique memory which stores calibration settings, it will never need recalibration. A rubber boot protects the ABS plastic housing delivering impact ratings not found in other economy models. Supplied with a 9368 Wall-mount bracket and lanyard.

	32311-K	32322-K
<b>Temperature Range:</b>	-40° to 500°F (-40° to 260°C)	-40° to 1000°F (-40° to 538°C)
<b>Accuracy:</b>	±1°F (±0.5°C)	±1°F (±0.5°C)
<b>Resolution:</b>	1°	1.0 / 0.1°
<b>Housing:</b>	ABS	ABS
<b>Hold:</b>	No	No
<b>Backlight:</b>	No	No
<b>Waterproof:</b>	No	No
<b>Power:</b>	(3) 1.5V AAA	(3) 1.5V AAA
<b>Battery Life:</b>	4500 hours	4500 hours
<b>Auto Off:</b>	10 min.	10 min.
<b>Wall Mounting Bracket:</b>	Yes	Yes
<b>Weight:</b>	6 oz (170 g)	6 oz (170 g)
<b>Regulatory Listings:</b>	CE  RoHS	CE
<b>Warranty:</b>	5-year Inst./ 1-year probe	5-year Inst./ 1-year probe

**32311-K  
EconoTemp™**

**32322-K  
EconoTemp™ Plus**  
 • High temperature range  
 • 10th degree resolution up to 495°F (257°C)



**94020-K  
EconoTemp™ Direct Connect  
Combo Pack**

- 32311-K Thermocouple Instrument
- 50337-K Direct Connect DuraNeedle Probe
- Wall-mount bracket
- Response Time: 1 second



**93230-K  
EconoTemp™ Combo Pack**

- 32311-K Thermocouple Instrument
- 50336-K DuraNeedle Probe
- Wall-mount bracket
- Response Time: 2 seconds





**AquaTuff™ Wrap&Stow™** Thermocouple Instruments have a unique memory chip that stores calibration settings. They are highly accurate, NIST traceable and most importantly, as the AquaTuff™ name implies, extremely durable and IPX7 waterproof rated for even greater reliability in harsh environments. Integral probe and cable storage enclosure designs are available where the probe is factory calibrated to the instrument. The AquaTuff™ 35100-K or 35200-K allow for maximum versatility since the instrument can be used with any Type K Thermocouple probes.

**35100-K  
AquaTuff™**



**35132  
AquaTuff™ Wrap&Stow™  
with DuraNeedle™ Probe**



**35135  
AquaTuff™ Wrap&Stow™  
with Angled Surface Probe**



**35140  
AquaTuff™ Wrap&Stow™  
with MicroNeedle Probe**



## AquaTuff™ 351 Series

### AquaTuff™ Series Wrap&Stow™ Probes

**DuraNeedle Probes** are best used to measure insertion and immersion temperatures. They are quick and durable for dependable performance, and are included with the 35132 and 35232. To order replacement DuraNeedle Probes, use model number 55032.



**MicroNeedle Probes** are designed to provide the greatest response times with minimal impact on the product, and are included with the 35140 and 35240 and 35340. To order replacement MicroNeedle Probes, use model number 55040.



**Surface Probes** are designed for use on any flat surface. Probe self-adjusts to the surface, giving superior contact and is included with the 35135 and 35235. To order replacement Surface Probes, use model number 55035.



	35100-K	35132	35135	35140
<b>Temperature Range:</b>	-100° to 999°F (-73° to 537°C)	-100° to 500°F (-73° to 260°C)	-100° to 500°F (-73° to 260°C)	-100° to 500°F (-73° to 260°C)
<b>Accuracy:</b>	±0.5°F (±0.3°C)	±0.9°F (±0.5°C) [1] Total System	±0.5°F (±0.3°C) [3]	±0.9°F (±0.5°C) [1] Total System
<b>Resolution:</b>	0.1°	0.1°	0.1°	0.1°
<b>Housing:</b>	ABS	ABS	ABS	ABS
<b>Hold:</b>	No	No	No	No
<b>Backlight:</b>	No	No	No	No
<b>Waterproof:</b>	Yes	Yes	Yes	Yes
<b>Power:</b>	(2) 1.5V AAA	(2) 1.5V AAA	(2) 1.5V AAA	(2) 1.5V AAA
<b>Battery Life:</b>	1800 hours	1800 hours	1800 hours	1800 hours
<b>Auto Off:</b>	10 min.	10 min.	10 min.	10 min.
<b>Wall Mounting Bracket:</b>	Optional	Optional	Optional	Optional
<b>Weight:</b>	5 oz (142 g)	7 oz (199 g)	8 oz (227 g)	7 oz (199 g)
<b>Regulatory Listings:</b>	CE  RoHS	CE  RoHS	CE  RoHS	CE  RoHS
<b>Warranty:</b>	5 year	5 year instrument/ 1 year probe	5 year instrument/ 1 year probe	5 year instrument/ 1 year probe

**NOTE:**

All EconoTemp™ Series and AquaTuff™ Series units are traceable to NIST standards.

[1] Total System Accuracy™ (probe and instrument) over entire range.

[2] Tenth degree/whole degree resolution, selectable.

[3] Accuracy spec for instrument only. Surface probe temperature error for flat, clean, oiled surfaces with 1kg pressure are typically within +1.5°C and -3.5°C without thermostat cycling.



**35200-K**  
AquaTuff™



**35232**  
AquaTuff™ Wrap&Stow™  
with DuraNeedle™ Probe



**35240**  
AquaTuff™ Wrap&Stow™  
with MicroNeedle Probe



## AquaTuff™ 352/353 Series

	35200-K	35232	35235	35240
<b>Temperature Range:</b>	-100° to 999°F (-73° to 537°C)	-100° to 500°F (-73° to 260°C)	-100° to 500°F (-73° to 260°C)	-100° to 500°F (-73° to 260°C)
<b>Accuracy:</b>	±0.5°F (±0.3°C)	±0.9°F (±0.5°C) [1] Total System	±0.5°F (±0.3°C) [3]	±0.9°F (±0.5°C) [1] Total System
<b>Resolution:</b>	0.1° [2]	0.1° [2]	0.1° [2]	0.1° [2]
<b>Housing:</b>	ABS	ABS	ABS	ABS
<b>Hold:</b>	Yes	Yes	Yes	Yes
<b>Backlight:</b>	Yes	Yes	Yes	Yes
<b>Waterproof:</b>	Yes	Yes	Yes	Yes
<b>Power:</b>	(2) 1.5V AAA	(2) 1.5V AAA	(2) 1.5V AAA	(2) 1.5V AAA
<b>Battery Life:</b>	1800 hours	1800 hours	1800 hours	1800 hours
<b>Auto Off:</b>	10 min.	10 min.	10 min.	10 min.
<b>Wall Mounting Bracket:</b>	Optional	Optional	Optional	Optional
<b>Weight:</b>	5 oz (142 g)	7 oz (199 g)	8 oz (227 g)	7 oz (199 g)
<b>Regulatory Listings:</b>	CE (NSF) RoHS	CE (NSF) RoHS	CE RoHS	CE (NSF) RoHS
<b>Warranty:</b>	5 year	5 year instrument/1 year probe	5 year instrument/ 1 year probe	5 year instrument/ 1 year probe

## IPX7 Waterproof

All the AquaTuff™ instruments are IPX7 waterproof rated and durable for harsh environments.

An IPX7 level reading means the instrument can be submerged in 1 meter of water for 30 minutes without water damage.

### 93916-K

#### Screen Print Kit

- 35200-K AquaTuff™ Thermocouple Instrument
- 50008-K Screen Print Donut Probe with 15' Cord
- 10830 Spare Wires
- 14235 Hard Carrying Case





# Type K Thermocouple Probes



Cooper-Atkins builds all of our probes in our Connecticut Headquarters facility, so you can rely on us to custom design and manufacture a probe for your specific needs. Cooper-Atkins probes are manufactured in an ISO 9001-2008 facility in the United States.

## Needle Probes

	31901-K	39035-K	49122-K	49135-K	50101-K	50143-K	50145-K	50207-K
<b>Description:</b>	1/8" Needle Probe - (Petite Handle)	1/8" Needle Probe	Ultra-Fine Product Probe	1/8" Rugged Needle Probe	Frozen Product Needle Probe	Heavy-Duty Needle Probe	1/8" Rugged Needle Probe	MicroNeedle Chisel Tip Probe (Direct Connect)
<b>Temperature Range:</b>	-40° to 400°F (-40° to 205°C)	-40° to 400°F (-40° to 205°C)	-100° to 500°F (-73° to 260°C)	-40° to 400°F (-40° to 205°C)	-40° to 400°F (-40° to 205°C)	-40° to 500°F (-40° to 260°C)	-40° to 500°F (-40° to 260°C)	-100° to 500°F (-73° to 260°C)
<b>Max Tip Temperature:</b>	400°F (205°C)	400°F (205°C)	500°F (260°C)	400°F (205°C)	400°F (205°C)	500°F (260°C)	500°F (260°C)	500°F (260°C)
<b>Max Cable Temperature:</b>	400°F (205°C)	400°F (205°C)	221°F (105°C)	400°F (205°C)	400°F (205°C)	176°F (80°C)	176°F (80°C)	-
<b>Response Time (liquid):</b>	4 seconds	4 seconds	3 seconds	4 seconds	4 seconds	5 seconds	4 seconds	1 second
<b>Shaft Length:</b>	4" (102 mm)	4" (102 mm)	4" (102 mm)	4" (102 mm)	3" (76 mm)	4" (102 mm)	4" (102 mm)	3.75" (95 mm)
<b>Cable Length Max Extended:</b>	24" (610 mm) w/ Silicone Jacket	36" (914 mm) w/ FEP Jacket	36" (914 mm) w/ PVC Jacket	36" (914 mm) w/ FEP Jacket	30" (762 mm) w/ Flexible Armored Cable	48" (1.2 m) w/ Polyurethane Jacket	48" (1.2 m) w/ Polyurethane Jacket	Direct Connect (no cable)
<b>Weight:</b>	1 oz (28 g)	1 oz (28 g)	1 oz (28 g)	4 oz (113 g)	1 lb (454 g)	5 oz (142 g)	4 oz (113 g)	0.5 oz (14 g)
<b>Warranty:</b>	1 year	1 year	1 year	1 year	1 year	1 year	1 year	1 year

50336-K DuraNeedle Probe



50012-K Angled Shaft Surface Bell Probe

## Needle Probes

	50209-K	50210-K	50263-K	50334-K	50335-K	50336-K	50337-K	50360-K	50361-K
<b>Description:</b>	MicroNeedle Probe	MicroNeedle Probe (Direct Connect)	60° Patty Probe	4" DuraNeedle Probe	4.5" Needle Probe	DuraNeedle Probe	DuraNeedle Probe (Direct Connect)	Oven Needle Probe	Meat Probe
<b>Temperature Range:</b>	-100° to 500°F (-73° to 260°C)	-100° to 500°F (-73° to 260°C)	-100° to 500°F (-73° to 260°C)	-100° to 500°F (-73° to 260°C)	-40° to 500°F (-40° to 260°C)	-40° to 500°F (-40° to 260°C)	-100° to 500°F (-73° to 260°C)	-40° to 500°F (-40° to 260°C)	-40° to 400°F (-40° to 205°C)
<b>Max Tip Temperature:</b>	500°F (260°C)	500°F (260°C)	500°F (260°C)	500°F (260°C)	500°F (260°C)	500°F (260°C)	500°F (260°C)	500°F (260°C)	400°F (205°C)
<b>Max Cable Temperature:</b>	176°F (80°C)	-	176°F (80°C)	400°F (205°C)	176°F (80°C)	176°F (80°C)	-	600°F (316°C)	400°F (205°C)
<b>Response Time (liquid):</b>	1 second	1 second	1 second	1 second	4 seconds	2 seconds	1 second	2 seconds	4 seconds
<b>Shaft Length:</b>	3.5" (89 mm)	3.75" (95 mm)	8" (203 mm)	4" (102 mm)	4.5" (114 mm)	6" (153 mm)	4" (102 mm)	5.5" (140 mm)	3.875" (98 mm)
<b>Cable Length Max Extended:</b>	48" (1.2 m) w/ Polyurethane Jacket	Direct Connect (no cable)	48" (1.2 m) w/ Polyurethane Jacket	34" (864 mm) w/ Fluoroelastomer Jacket	48" (1.2 m) w/ Polyurethane Jacket	48" (1.2 m) w/ Polyurethane Jacket	Direct Connect (no cable)	35" (889 m) w/ Stainless Steel Overbraid	10' (3 m) w/ Flexible Armor
<b>Weight:</b>	2 oz (57 g)	0.5 oz (14 g)	3 oz (85 g)	2 oz (57 g)	2 oz (57 g)	2 oz (57 g)	0.5 oz (14 g)	1 oz (28 g)	6 oz (170 g)
<b>Warranty:</b>	1 year	1 year	1 year	1 year	1 year	1 year	1 year	1 year	1 year



4005MK Pipe Clamp Probe

## High Temperature Probes

	49126-K	49127-K	49140-K	50426-K	50427-K	4005MK	54011-K	50200-K	50208-K
<b>Description:</b>	Reduced Tip Puncture Probe	Reduced Tip Probe (Direct Connect)	High Temperature Probe	4" Reduced Tip Probe	12" Reduced Tip Probe	Pipe Clamp Surface Probe	Pipe Strap Surface Probe	High Temperature Probe	Fry Vat Insertion Probe
<b>Temperature Range:</b>	32° to 932°F (0° to 500°C)	32° to 932°F (0° to 500°C)	32° to 2012°F (0° to 1100°C)	32° to 932°F (0° to 500°C)	32° to 932°F (0° to 500°C)	-20° to 300°F (-29° to 149°C)	-25° to 300°F (-32° to 149°C)	-40° to 400°F (-40° to 205°C)	-40° to 400°F (-40° to 205°C)
<b>Max Tip Temperature:</b>	932°F (500°C)	932°F (500°C)	2012°F (1100°C)	932°F (500°C)	932°F (500°C)	300°F (149°C)	300°F (149°C)	400°F (205°C)	400°F (205°C)
<b>Max Cable Temperature:</b>	400°F (205°C)	-	400°F (205°C)	176°F (80°C)	176°F (80°C)	220°F (104°C)	220°F (104°C)	400°F (205°C)	400°F (205°C)
<b>Response Time:</b>	1 second liquid	1 second liquid	2 seconds liquid	1 second liquid	1 second liquid	2 seconds on pipe	Varies on pipe	12 seconds liquid	8 seconds liquid
<b>Shaft Length:</b>	4" (102 mm)	4" (102 mm)	24" (610 mm)	4" (102 mm)	12" (305 mm)	-	-	8" (203 mm)	7.3" (185 mm)
<b>Cable Length Max Extended:</b>	36" (914 mm) w/ FEP Jacket	Direct Connect (no cable)	36" (914 mm) w/ Flexible Armor	48" (1.2 m) w/ Polyurethane Jacket	48" (1.2 m) Polyurethane Jacket	10' (3 m) w/ Polyurethane Jacket	10' (3 m) w/ Polyurethane Jacket	36" (914 mm) w/ FEP Jacket	30" (762 mm) w/ Flexible Armor
<b>Weight:</b>	4 oz (113 g)	.5 oz (14 g)	6 oz (170 g)	5 oz (142 g)	5 oz (142 g)	5 oz (142 g)	2 oz (57 g)	2 oz (57 g)	3 oz (85 g)
<b>Warranty:</b>	1 year	1 year	1 year	1 year	1 year	1 year	1 year	1 year	1 year

## Pipe Probes

## Fry Vat Probes



54011-K Pipe Strap Probe



## Air Probes

	31903-K	31905-K	39032-K	49138-K	50302-K	50305-K	50306-K	50332-K	50338-K
<b>Description:</b>	Hand-held Air Probe	Bare Tip Air Probe	Hand-Held Air Probe	Bare Tip Air Probe	Industrial Air Probe	Freezer/Cooler Probe	Oven/Freezer Probe	Hand-Held Air Probe	Industrial Air Probe
<b>Temperature Range:</b>	-40° to 400°F (-40° to 205°C)	-40° to 400°F (-40° to 205°C)	-328° to 400°F (-200° to 205°C)	32° to 896°F (0° to 480°C)	32° to 896°F (0° to 480°C)	-40° to 400°F (-40° to 205°C)	-100° to 600°F (-73° to 316°C)	-100° to 500°F (-73° to 260°C)	32° to 896°F (0° to 480°C)
<b>Max Tip Temperature:</b>	400°F (205°C)	400°F (205°C)	400°F (205°C)	896°F (480°C)	896°F (480°C)	400°F (205°C)	600°F (316°C)	500°F (260°C)	896°F (480°C)
<b>Max Cable Temperature:</b>	400°F (205°C)	400°F (205°C)	400°F (205°C)	896°F (480°C)	896°F (480°C)	176°F (80°C)	600°F (316°C)	176°F (80°C)	896°F (480°C)
<b>Response Time :</b>	9 seconds in 5 m/sec. air	1 sec. liquid & 3 sec. 5 m/sec. air	11 seconds in 5 m/sec. air steam	1 second liquid 9 sec. 5 m/sec. air	1 second liquid 10 sec. 5 m/sec. air	25 seconds air	1 second liquid 10 sec. 5 m/sec. air	10 seconds in 5 m/sec. air	1 second liquid 9 seconds in 5 m/sec. air
<b>Shaft Length:</b>	4" (102 mm)	-	4" (102 mm)	-	2.125" (54 mm)	-	2.125" (54 mm)	4" (102 mm)	-
<b>Cable Length Max Extended:</b>	24" (610 mm) w/ Silicone Jacket	24" (610 mm) w/ Silicone Jacket	36" (914 mm) w/ FEP Cable	48" (1.2 m) w/ Fiberglass Jacket	46.5" (1.2 m) w/ Fiberglass Jacket	24" (610 mm) w/ FEP Jacket	43" (1.1 m) w/ Stainless Steel Overbraid	48" (1.2 m) w/ Polyurethane Jacket	48" (1.2 m) w/ Fiberglass Jacket
<b>Weight:</b>	1 oz (28 g)	1 oz (28 g)	1 oz (28 g)	1 oz (28 g)	1 oz (28 g)	3 oz (85 g)	1 oz (28 g)	2 oz (57 g)	1 oz (28 g)
<b>Warranty:</b>	1 year	1 year	1 year	1 year	1 year	1 year	1 year	1 year	1 year

**50306-K**  
Air Probe for oven or cooler/freezer with clip



## Surface Probes

	31907-K	50001-K	50008-K	50010-K	50012-K	50014-K	50069-K	50316-K	50318-K	50319-K	50405-K
<b>Description:</b>	Surface Probe - petite handle	Right Angle Bell Surface Probe	Silkscreen Probe	Tape Surface Probe	120° Angled Shaft Surface Bell Probe	Weighted Griddle Surface Probe	Moving Surface Bow Probe	1/8" Surface/Immersion Probe - flat tip	Ceramic Tip Surface Probe	90° Ceramic Tip Surface Probe	Blunt Tip Probe
<b>Temperature Range:</b>	-40° to 400°F (-40° to 205°C)	-40° to 400°F (-40° to 205°C)	-40° to 400°F (-40° to 205°C)	-40° to 400°F (-40° to 205°C)	-40° to 500°F (-40° to 260°C)	-40° to 500°F (-40° to 260°C)	-40° to 500°F (-40° to 260°C)	-100° to 500°F (-73° to 260°C)	-40° to 1202°F (-40° to 650°C)	-40° to 1202°F (-40° to 650°C)	-100° to 500°F (-73° to 260°C)
<b>Max Tip Temperature:</b>	400°F (205°C)	400°F (205°C)	400°F (205°C)	400°F (205°C)	500°F (260°C)	500°F (260°C)	500°F (260°C)	500°F (260°C)	1202°F (650°C)	1202°F (650°C)	500°F (260°C)
<b>Max Cable Temperature:</b>	400°F (205°C)	400°F (205°C)	400°F (205°C)	400°F (205°C)	176°F (80°C)	400°F (205°C)	221°F (105°C)	176°F (80°C)	176°F (80°C)	176°F (80°C)	-
<b>Response Time:</b>	5 seconds on (oiled surface)	7 seconds (oiled surface)	1 second (liquid)	9 seconds on (metal surface)	4 seconds (oiled surface)	2 seconds (oiled surface)	4 seconds (oiled surface)	6 seconds (metal surface) / 1 second (liquid)	1 second (oiled surface)	1 second (oiled surface)	6 seconds (oiled surface) 1 second (liquid)
<b>Shaft Length:</b>	4" (102 mm)	9" (229 mm)	-	-	4.5" (114 mm)	-	8" (203 mm)	4" (102 mm)	4" (102 mm)	5" (127 mm)	7.5" (190 mm)
<b>Cable Length Max Extended:</b>	24" (610 mm) w/ Silicone Jacket	30" (762 mm) w/ Flexible Armored Cable	15" (381 mm) w/ Silicone Jacket	36" (914 mm) w/ FEP Jacket	48" (1.2 m) w/ Polyurethane Jacket	30" (762 mm) w/ Flexible Armored Cable	36" (914 mm) w/ PVC Jacket	48" (1.2 m) w/ Polyurethane Jacket	48" (1.2 m) w/ Polyurethane Jacket	48" (1.2 m) w/ Polyurethane Jacket	Direct Connect (no cable)
<b>Weight:</b>	1 oz (28 g)	6 oz (170 g)	3 oz (85 g)	1 oz (28 g)	5 oz (142 g)	2 lbs (907 g)	6 oz (170 g)	2 oz (57 g)	5 oz (142 g)	6 oz (170 g)	.5 oz (14 g)
<b>Warranty:</b>	1 year	1 year	1 year	1 year	1 year	1 year	1 year	1 year	1 year	1 year	1 year

## Miscellaneous Probes

	39138-K	49136-K	50121-K	50415-K	50701-K	52048-K
<b>Description:</b>	Bare-Tip Probe	Bendable Tip Probe	Racing Tire Probe	Dishwasher Probe	Combo Probe	Product Simulator
<b>Temperature Range:</b>	-328° to 400°F (-200° to 205°C)	32° to 1652°F (0° to 900°C)	-40° to 500°F (-40° to 260°C)	-67° to 221°F (-55° to 105°C)	-100° to 500°F (-73° to 260°C)	-40° to 180°F (-40° to 82°C)
<b>Max Tip Temperature:</b>	400°F (205°C)	1652°F (900°C)	500°F (260°C)	221°F (105°C)	500°F (260°C)	180°F (82°C)
<b>Max Cable Temperature:</b>	400°F (205°C)	221°F (105°C)	176°F (80°C)	221°F (105°C)	400°F (205°C)	-
<b>Response Time :</b>	1 sec. liquid & 7 sec. 5 m/sec. air	1 second liquid	1 second liquid	9 seconds in 5 m/sec. air	2 seconds liquid	Stabilization of Simulator - up to 2 hours
<b>Shaft Length:</b>	-	7" (178 mm)	0.1875" (5 mm)	-	35" (889 mm)	-
<b>Cable Length Max Extended:</b>	36" (914 mm) w/ FEP Jacket	36" (914 mm) w/ PVC Jacket	48" (1.2 m) w/ Polyurethane Jacket	15' (4.6 m) w/ PVC Jacket	36" (914 mm) w/ Fluoroelastomer Jacket	6" (152 mm) Flexible Cable w/ FEP Jacket
<b>Weight:</b>	1 oz (28 g)	1 oz (28 g)	4 oz (113 g)	3 oz (85 g)	15 oz (425 g)	2.5 oz (71 g)
<b>Warranty:</b>	1 year	1 year	1 year	1 year	1 year	1 year

**52048-K**  
Product Simulator Probe



**49136-K**  
Bendable TipProbe



NOTE: Most probes are available in Type J and Type T configurations.

# Digital Panel Thermometers

Cooper-Atkins' panel meters allow you to obtain accurate interior temperature readings remotely from outside the cabinet. They reduce the frequency of opening your cooler/freezer door and keep the cold air in and the hot air out. All are designed for retro-fit applications.

	SP160-0 SP160-01	SP120	PM120	PM180
<b>Temperature Range:</b>	-58° to 158°F (-50° to 70°C)	-58° to 158°F (-50° to 70°C)	-40° to 122°F (-40° to 50°C)	-25° to 180°F (-32° to 82°C)
<b>Accuracy:</b>	±1°F (0.5°C) from 32° to 122°F (0 to 50°C) ±2°F from -4° to 32°F (-20° to 50°C) ±3.6°F/2°C <-4°F (-20°C) and > 122°F (50°C)	±2°F (±1°C)	±1.8°F (±1°C) from -4° to 122°F (-20° to 50°C) ±3.6°F (±2°C) below -4°F (20°C)	±2°F (±1°C)
<b>Resolution:</b>	0.1°	0.1°	0.1°	0.1°/1% RH
<b>Ambient Operating Range:</b>	0° to 120°F up to 90% non-condensing	0° to 120°F up to 90% non-condensing	0° to 120°F up to 90% non-condensing	0° to 120°F up to 90% non-condensing
<b>Response Time:</b>	10 second updates	30 seconds 10 second updates	30 seconds	5 second updates
<b>LCD:</b>	1.4" x 0.5" (36 mm x 13 mm)	1.875" x 0.625" (48 mm x 16 mm)	1.875" x 0.625" (48 mm x 16 mm)	1.875" x 0.625" (48 mm x 16 mm)
<b>Lead Length:</b>	48" (1.2 m)	10' (3 m)	39" (1 m)	39" (1 m)
<b>Case Material:</b>	ABS	ABS	Polycarbonate	Polycarbonate
<b>Case Dimensions:</b>	4.5" x 1.125" x .625" (114 mm x 29 mm x 16 mm)	2.75" x 2.75" x .75" (70 mm x 70 mm x 19 mm)	2.7" x 1.4" x 1.1" (69 mm x 36 mm x 28 mm)	2.75" x 1.5" x 1" (70 mm x 38 mm x 25 mm)
<b>Power:</b>	Solar w/ battery back-up (1) 1.5V AAA	Solar w/ battery back-up (1) 1.5V A76	(1) 1.5V AA	(1) 1.5V AA
<b>Mounting:</b>	Hangs	Hangs	Optional Mounting Flange (Model 9302)	Hangs of Stands
<b>Weight:</b>	3 oz (85 g)	2.5 oz (71 g)	2 oz (57 g)	5 oz (142 g)
<b>Regulatory Listings:</b>	CE RoHS	CE RoHS	CE RoHS	CE RoHS
<b>Warranty:</b>	1 year	1 year	1 year	1 year

## SP Series Solar Powered Instruments

Meter operates using ambient light (natural, fluorescent and incandescent) and have a Lux rating above 100. When the ambient light is not strong enough to power the meter, the 1.5V battery automatically turns the back-light unit on.

### SP160-0 Solar Powered Panel Meter

- 4' cord
- Black case



### SP160-1 Solar Powered Panel Meter

- 4' cord
- White case



### SP120 Solar Powered Panel Meter

- 10' cord



### PM120 Mini Remote-Reading Thermometer

For use when mounting space is limited.

- Min/Max feature
- 9302 Mounting flange available



*NOTE: PM120 & PM180 are not solar powered instruments*

## PM180

### Dual-Cool™ Panel Thermometer

- Min/Max alarm settings
- Hi/Lo temperature recall
- Interchangeable probes



### PM180-01

- PM180 Panel Thermometer
- 2013 Air Probe
- 2113 Solid Simulator Probe

### PM180-02

- PM180 Panel Thermometer
- (2) 2013 Air Probe

### PM180-03

- PM180 Panel Thermometer
- (2) 2113 Solid Simulator Probe



# Digital Panel Thermometers

	PMRH120	DM120 Series	DM450	DTT361
<b>Temperature Range:</b>	-12° to 140°F (-24° to 60°C)	-40° to 120°F (-40° to 48°C)	-40° to 450°F (-40° to 230°C)	-25° to 392°F (31° to 200°C)
<b>Accuracy:</b>	±2°F (±1°C) ±5% RH from 30° to 75%RH/ at 32° to 122°F (0° to 50°C)	±2°F (±1°C)	±2°F (±1°C) from -40° to 300°F ±2% of reading from 301° to 450°F	±2°F (±1°C) from -4° to 302°F (-20°C to 150°C) ±3°F (±1.5°C) outside range
<b>Resolution:</b>	0.1°/1% RH	0.1°	0.1°	0.1°
<b>Ambient Operating Range:</b>	0° to 120°F up to 90% non-condensing	15° to 150°F up to 90% non-condensing	0° to 150°F up to 90% non-condensing	32° to 122°F (0° to 50°C) / 20 to 90%RH
<b>Response Time:</b>	5 seconds	30 second updates	30 seconds 10 second updates	-
<b>LCD:</b>	1.875" x 0.625" (48 mm x 16 mm)	1.3" x 0.5" (33 mm x 13 mm)	1.3" x 0.5" (33 mm x 13 mm)	2.25" x 1.5" (57mm x 38mm)
<b>Lead Length:</b>	39" (1 m)	39" (1 m)	39" (1 m)	44" (1.1 m)
<b>Case Material:</b>	Polycarbonate	Stainless Steel	Stainless Steel	ABS Plastic
<b>Case Dimensions:</b>	2.75" x 1.5" x 1" (70 mm x 38 mm x 25 mm)	<b>DM120</b> 3.0" x 1.375" (76 mm x 27 mm) <b>DM120S</b> 3.47" x 1.1" (88 mm x 28 mm)	<b>DM450</b> 3.0" x 1.375" (76 mm x 27 mm)	3" x 1.30" X 4.12" (76mm x 33mm x 105mm (without probe))
<b>Power:</b>	(1) 1.5V AA	(1) 1.5V #LR754	(1) 1.5V #LR754	(3) AAA
<b>Mounting:</b>	Optional Front Flange	<b>DM120</b> Front Flange <b>DM120S</b> Back Flange	Front Flange	Wire hanger with magnet
<b>Weight:</b>	2.5 oz (71 g)	<b>DM120</b> 2.5 oz (71 g) <b>DM120S</b> 3.5 oz (999 g)	3 oz (85 g)	7oz (198g(including probe))
<b>Regulatory Listings:</b>	CE RoHS	CE NSF RoHS	CE RoHS	CE RoHS
<b>Warranty:</b>	1 year	1 year	1 year	1 year

## PMRH120 Mini Remote-Reading Thermometer/Hygrometer

- Min/Max feature
- 9302 Mounting flange available



## DM120/DM450 Series

Front flange for flush mounting or back flange for surface mounting to cabinet and/or enclosure. The removable 2" (51 mm) diameter polycarbonate lens makes battery replacement easy.

## DM120 Front Flange Back Connect Panel Thermometer



## DM450 Front Flange Back Connect Panel Thermometer



## DTT361-01 Cooking Thermo/Timer

- Wall-mount bracket with magnet
- Temperature/Time/Alarm
- Water resistant (IPX 4)



# Vapor Tension Panel Thermometers

Used in many HVAC/R applications, these units are the perfect choice for use in walk-in refrigerators, tanks, refrigerated display cases, holding and specialty cabinets, dairy cases, freezers, floral displays and much more. They are able to obtain interior temperature readings remotely from outside of the cabinet and can be retro-fitted.

- Nickel/tin-plated bulb and capillary
- Polycarbonate lens/bezel
- Stainless steel cases

**6142-20**  
Front Flange  
Back Connect Panel  
Thermometer



**6642-12**  
Remote Vapor Tension  
Panel Thermometer



**6742-19**  
U Bracket Back  
Connect Panel  
Thermometer



**6812-02**  
Back Flange Back  
Connect Panel  
Thermometer



**7112-05**  
Front Flange Back  
Connect Panel  
Thermometer



	6142-06	6142-13	6142-20	6142-58
<b>Temperature Range:</b>	40° to 240°F (10° to 115°C)	-40° to 120°F (-40 to 50°C)	-40° to 60°F (-40° to 15°C)	-40° to 60°F (-40° to 15°C)
<b>Accuracy:</b>	±2°F (±1°C) from 140° to 210°F (60 to 99°C)	±2°F (±1°) at 10° and 40°F (-12° and 4.5°C) ±5°F (±2.5°C) at 110°F (43°C)	±2°F (±1°C) at 10° to 40°F (-12° to 4.5°C)	±2°F (±1°C) at 10° to 40°F (-12° to 4.5°C)
<b>Dial Dimension:</b>	2" (51 mm)	2" (51 mm)	2" (51 mm)	2" (51 mm)
<b>Capillary Length:</b>	48" (1.2 m)	48" (1.2 m)	48" (1.2 m)	20' (6.1 m)
<b>Flange:</b>	Front	Front	Front	Front
<b>Connection:</b>	Back	Back	Back	Back
<b>Mounting:</b>	Flush	Flush	Flush	Flush
<b>Weight:</b>	5 oz (142 g)	5 oz (142 g)	5 oz (142 g)	7 oz (198 g)
<b>Regulatory Listings:</b>	RoHS	RoHS	RoHS	RoHS
<b>Warranty:</b>	1 year	1 year	1 year	1 year

	6642-06	6642-12	6742-19	6812-01	6812-02
<b>Temperature Range:</b>	-40° to 60°F (-40° to 15°C)	40° to 240°F (10 to 115°C)	-40° to 60°F (-40° to 15°C)	-40° to 60°F (-40° to 15°C)	-40° to 120°F (-40° to 50°C)
<b>Accuracy:</b>	±2°F (±1°C) at 10° to 40°F (-12° and 4.5°C)	±2°F (±1°C) from 140° to 210°F (60° to 99°C)	±2°F (±1°C) at 10° to 40°F (-12° and 4.5°C)	±2°F (±1°C) at 10° to 40°F (-12° to 4.5°C)	±2°F (±1°C) at 10° to 40°F (-12° and 4.5°C) ±5°F (±2.5°C) at 110°F (43°C)
<b>Dial Dimension:</b>	2" (51 mm)	2" (51 mm)	2" (51 mm)	2" (51 mm)	2" (51 mm)
<b>Capillary Length:</b>	48" (1.2 m)	48" (1.2 m)	48" (1.2 m)	48" (1.2 m)	48" (1.2 m)
<b>Flange:</b>	Strap Hanger no flange	Strap Hanger no flange	U-Bracket no flange	Back	Back
<b>Connection:</b>	Bottom	Bottom	Back	Back	Back
<b>Mounting:</b>	-	-	-	Surface	Surface
<b>Weight:</b>	5 oz (142 g)	5 oz (142 g)	5.6 oz (158.9 g)	5 oz (142 g)	5 oz (142 g)
<b>Regulatory Listings:</b>	RoHS	RoHS	RoHS	RoHS	RoHS
<b>Warranty:</b>	1 year	1 year	1 year	1 year	1 year

	7112-01	7112-02	7112-05	7612-06
<b>Temperature Range:</b>	-40° to 60°F (-40° to 15°C)	-40° to 120°F (-40 to 50°C)	40° to 240°F (10° to 115°C)	-40° to 60°F (-40° to 15°C)
<b>Accuracy:</b>	±2°F (±1°C) at 10° to 40°F (-12° to 4.5°C)	±2°F (±1°C) at 10° and 40°F (-12° and 4.5°C) ±5°F (2.5°C) at 110° (-43°C)	±2°F (±1°C) from 140° to 210°F (60° to 99°C)	±2°F (±1°C) at 10° to 40°F (-12° and 4.5°C)
<b>Dial Dimension:</b>	2.5" (64 mm)	2.5" (64 mm)	2.5" (64 mm)	2.5" (64 mm)
<b>Capillary Length:</b>	48" (1.2 m)	48" (1.2 m)	48" (1.2 m)	48" (1.2 m)
<b>Flange:</b>	Front	Front	Front	Strap Hanger
<b>Connection:</b>	Back	Back	Back	Bottom
<b>Mounting:</b>	Flush	Flush	Flush	-
<b>Weight:</b>	7 oz (198 g)	7 oz (198 g)	7 oz (198 g)	5.6 oz (159 g)
<b>Regulatory Listings:</b>	RoHS	RoHS	RoHS	RoHS
<b>Warranty:</b>	1 year	1 year	1 year	1 year

# Bi-Metal Thermometers

To ensure accuracy minimum insertion point 2" (51 mm)

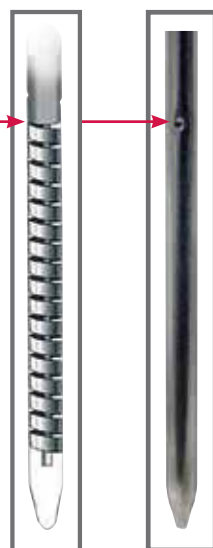

**CT180-51**  
Pocket Test Thermometer

## Antimicrobial

*The antimicrobial additive does not protect users or others against food bacteria. Always wash, rinse and sanitize this product thoroughly before and after each use.*

All 1" Pocket-tests are field adjustable and include a red, protective sheath with calibration wrench made with antimicrobial plastic.

	1246 Series	CT Series	2236-02	2238-06	2238-14
<b>Temperature Range:</b>	1246-01: -40° to 180°F 1246-01C: -40° to 80°C 1246-02: 0° to 220°F 1246-02C: -20° to 100°C 1246-03: 50° to 550°F 1246-03C: 10° to 285°C	CT180-51: -40° to 180°F CT220-51: 0° to 220°F	-40° to 180°F (-40° to 80°C)	0° to 220°F (-10° to 100°C)	50° to 550°F (10° to 288°C)
<b>Accuracy:</b>	1246-01: ±2°F 1246-01C: ±1°C 1246-02: ±2°F 1246-02C: ±1°C 1246-03: ±5°F 1246-03C: ±3°C	±2°F	±2°F (±1°C)	±2°F (±1°C)	±5°F (±3°C)
<b>Dial Diameter:</b>	1" (25 mm)	1" (25 mm)	2" (50 mm)	2" (50 mm)	2" (50 mm)
<b>Lens Material:</b>	Magnifying Polycarbonate	Magnifying Polycarbonate	Tempered Glass	Tempered Glass	Tempered Glass
<b>Stem Length:</b>	5" (127 mm)	5" (127 mm)	5" (127 mm)	8" (203 mm)	8" (203 mm)
<b>Weight:</b>	0.5 oz (14 g)	11 oz (312 g)	1.5 oz (43 g)	1.2 oz (35.4 g)	1.5 oz (43 g)
<b>Regulatory Listings:</b>	NSF	-	-	NSF	NSF
<b>Warranty:</b>	1 year	1 year	1 year	1 year	1 year



**2238-06**  
Stem-Test Thermometer  
• Vessel clip included

Developed for through-wall mounting, all units have a bi-metal coil movement and glass lens with a 0.25" (6.35 mm) diameter stainless steel stem. The stainless steel, back flange bezel has three, equally spaced mounting holes 0.150" (3.81 mm) diameter on a 2.9" (74 mm) diameter bolt circle.

	2225 Series	2245 Series	2255 Series
<b>Temperature Range:</b>	2225-02: 0° to 220°F 2225-03: -40° to 160°F 2225-20: 200° to 1000°F (100° to 500°C)	2245-02: 0° to 220°F 2245-03: -40 to 160°C	2255-02: 0° to 220°F 2255-03: -40 to 160°C
<b>Accuracy:</b>	2225-02: ±2°F 2225-03: ±3°F 2225-20: ±20°F (±10°C)	2245-02: ±2°F 2245-03: ±3°F	2255-02: ±2°F 2255-03: ±3°F
<b>Dial Dimension:</b>	2" (50 mm)	2" (50 mm)	2" (50 mm)
<b>Outer Flange Diameter:</b>	2225-02: 3.5" (89 mm) 2225-03: 3.5" (89 mm) 2225-20: 3.5" (89 mm)	3.5" (89 mm)	3.5" (89 mm)
<b>Stem Length:</b>	4" (102 mm)	6" (152 mm)	9" (229 mm)
<b>Weight:</b>	2.5 oz (71 g)	3 oz (85 g)	3.8 oz (108 g)
<b>Warranty:</b>	1 year	1 year	1 year



**2225-20**  
Pizza Oven Flange Mount  
Thermometer - Dual Scale



# AFL Digital Pocket Test Thermometers



A digital pocket-test thermometer that is “**Accurate for Life**” and does **NOT** require any field adjustment. Eliminating field adjustment removes the risk of introducing inaccuracy into the instrument. Cooper-Atkins brings this industry leading advancement with the guarantee that our **Digital Pocket Tests** are always accurate. Look for the logo  on Cooper-Atkins products and you’ll know they are **Accurate for Life...GUARANTEED!!**

Cooper-Atkins offers a wide range of fast-response, Accurate for Life, Digital Pocket Tests with 0.1° resolution. Thermistor sensors are located in the probe tip for quick response time and accurate readings.



**DPP400W**  
**Pen-Style Digital**  
**Pocket Test Thermometer**

- Min, Max & Hold temperature
- IPX7 waterproof rated



**DFP450W**  
**Digital Pocket Test**  
**with Temperature Alarm**

- Min/Max & Hold Temperature
- IPX7 Waterproof rated
- Dishwasher safe



**DPP800W**  
**MAX Digital Pocket**  
**Test Thermometer**

- Large EZ-read LCD screen
- IPX7 Waterproof rated
- Dishwasher safe

**TTM41 & TTM41-10**  
**Coolit-Rite™ Cooling Validator**  
Validator with 15” stem (TTM41) or 10” stem (TTM41-10) tracks elapsed time while it monitors the temperature of the food being cooled.

- Adjustable vessel clip
- Water-resistant



## Antimicrobial







*The antimicrobial additive does not protect users or others against food bacteria. Always wash, rinse and sanitize this product thoroughly before and after each use.*

## IPX7 Waterproof

All the **Accurate for Life Pocket Test** instruments are IPX7 waterproof rated and durable for harsh environments.

An IPX7 level reading means the instrument can be submerged in 1 meter of water for 30 minutes without water damage.

# Digital Pocket Test Thermometers

	DFP450W	DPP400W	DPP800W	DPS300-01	DT300	TTM41	TTM41-10
<b>Temperature Range:</b>	-40° to 450°F (-40° to 232°C)	-40° to 392°F (-40° to 200°C)	-40° to 450°F (-40° to 232°C)	-40° to 302°F (-40° to 150°C)	-40° to 302°F (-40° to 150°C)	-4° to 302°F (-20° to 150°C)	-4° to 302°F (-20° to 150°C)
<b>Accuracy:</b>	±2°F (±1°C)	±2°F (±1°C)	±1°F (±0.5°C)	±2°F (±1°C)	±2°F (±1°C)	±2°F (±1°C)	±2°F (±1°C)
<b>Resolution:</b>	0.1°F	0.1°F	0.1°F	0.1°F	0.1°F	0.1°F	0.1°F
<b>Display - LCD</b>	.875" (22 mm)	.875" (22 mm)	1.5" (38 mm)	.50" (13 mm)	.875" (22 mm)	1.25" (32 mm)	1.25" (32 mm)
<b>Stem Length:</b>	4.75" (121 mm)	2.75" (70 mm)	4" (102 mm)	4.75" (121 mm)	4.625" (117 mm)	15" (381 mm)	10" (254 mm)
<b>Power:</b>	(1) 1.5V #LR44	(1) 1.5V #LR44	(1) 1.5V #LR44	(1) 1.5V #LR44	(1) 1.5V #LR44	(1) 1.5V #LR44	(1) 1.5V #LR44
<b>Auto Shut-off:</b>	Yes (After 10 min)	Yes (After 10 min)	Yes (After 10 min)	Yes (After 10 min)	No	-	-
<b>Weight:</b>	.7 oz (20 g)	1 oz (28 g)	1 oz (28 g)	1 oz (28 g)	.5 oz (14 g)	2 oz (56 g) (with clip)	2 oz (56 g) (with clip)
<b>Water Resistance Rating:</b>	IPX7	IPX7	IPX7	-	-	Water Resistant	Water Resistant
<b>Regulatory Listings:</b>	CE  RoHS	CE  RoHS	CE  RoHS	CE  RoHS	CE  RoHS	CE  RoHS	CE  RoHS
<b>Warranty:</b>	Lifetime	Lifetime	Lifetime	1 year	1 year	Lifetime	Lifetime

## DPS300-01 Digital Pocket Test with 180° Swivel Head

- On/Off Buttons
- °F/°C Switchable
- Memory Feature
- Reduced Tip Design

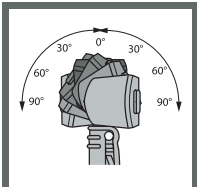

Adjustable 180°  
Swivel Head for  
Easy Viewing  
From Any Angle



## DT300 Oval Style Digital Pocket Test

- On/Off Buttons
- °F/°C Switchable



## ValCup™

### 9325 ValCup™ Thermometer Validation Cup

- Quickly validate thermometer accuracy
- Commercial dishwasher safe
- BPA-free acrylic
- 6.25" x 4" (159 mm x 102 mm)
- Weight: 6 oz (170 g)

Make the perfect ice bath  
using the ValCup™

Watch the Video



## Probe Wipes

### 9150 Box

- 200 individual foil wrapped wipes per pack
- 2" x 2" (51 mm x 51 mm)
- Weight: 8 oz (227 g)



# Infrared Thermometers

	412	462	470	480	481
<b>Temperature Range:</b>	Infrared -76° to 932°F (-60° to 500°C) Thermocouple Instrument -83° to 1999°F (-64° to 1400°C)	-40° to 536°F (-40° to 280°C)	-27° to 428°F (-33° to 220°C)	Infrared -27° to 428°F (-33° to 220°C) Thermocouple Probe -67° to 624°F (-55° to 330°C)	Infrared -40° to 536°F (-40° to 280°C) Thermocouple Probe -40° to 392°F (-40° to 200°C)
<b>Infrared Accuracy:</b>	±4°F (±2°C)	±2°F (1°C)	±3.6°F (±2°C)	±4°F (±2°C)	±2°F (±1°C)
<b>Probe Accuracy:</b>	Thermocouple Jack ±2°F (±1°C)	-	-	Thermocouple Probe ±2°F (±1°C)	RTD Probe ±1°F (0.5°C)
<b>Resolution:</b>	0.1° 1°F above 200°F	0.1° 1°F above 230°F	0.1° 1°F above 200°F	0.1° 1°F above 200°F	0.1°
<b>Ambient Operating Range:</b>	32° to 122°F (0° to 50°C)	32° to 120°F (0° to 50°C)	32° to 122°F (0° to 50°C)	32° to 122°F (0° to 50°C)	32° to 122°F (0° to 50°C)
<b>Laser:</b>	Single Dot	Single Dot	-	-	Single Dot
<b>Distance to Spot (D:S):</b>	12:1	6:1	1:1	1:1	3:1
<b>Emissivity:</b>	0.95 - adjustable from 0.1 to 1.0	0.97 fixed	Preset at 0.95	0.95 - adjustable from 0.1 to 1.0	0.97 Fixed
<b>Storage Temperature:</b>	-4° to 149°F (-20° to 65°C)	-4° to 149°F (-20° to 65°C)	-4° to 149°F (-20° to 65°C)	-4° to 149°F (-20° to 65°C)	-4° to 122°F (-20° to 50°C)
<b>Power:</b>	(2) 1.5V AAA	(1) 9V battery Alkaline	(1) Lithium button cell 3V battery - #CR2032	(1) Lithium button cell 3V battery - #CR2032	(1) 9V battery
<b>Dimensions:</b>	6.9" x 2.8" x 1.5" (175 mm x 72 mm x 38 mm)	7.375" x 2.25" x 1.5" (184 mm x 56 mm x 38 mm)	2.67" x 1.44" x 0.75" (68 mm x 36 mm x 19 mm)	6.125" x 1.68" x 1.625" (155 mm x 41 mm x 22 mm)	6.625" x 1.375" x 2.5" (168 mm x 35 mm x 64 mm)
<b>Battery Life:</b>	180 Hours Typical 140 Hours Minimum	12 Hours	40 Hours Typical 30 Hours Minimum	40 Hours Typical 30 Hours Minimum	100 Hours Typical
<b>Weight:</b>	6 oz (170 g)	5 oz (142 g)	1 oz (28.4 g)	2.5 oz (73 g)	6 oz (170 g)
<b>Regulatory Listings:</b>	CE RoHS	CE RoHS	CE RoHS	CE RoHS	CE RSE RoHS
<b>Warranty:</b>	1 year	1 year	1 year	1 year	1 year

## 412 Infrared with Laser Sighting & Thermocouple Jack

- LCD display with backlight
- FDA Class II, Single-point laser may be turned on or off
- High/Low alarms
- Measures min, max, average & differential temperatures
- Accepts all Type K Thermocouple probes
- Lock-mode for continuous monitoring up to 60 minutes
- Adjustable emissivity
- Soft carrying case included



## 462 Slim-Line Infrared Thermometer

- Easy to use. Just aim at the object, press the button, and read the surface temperature.
- LCD display with backlight
  - Single-point laser
  - Auto Shut-off after 7 seconds



## 470 Mini Infrared Thermometer

- The pocket-sized design is very compact, and includes lanyard to wear around your neck.
- Min/Max/Hold/Lock



## 480 Dual Temp Infrared & Probe

- For surface and internal temperature readings.
- Auto Shut-off after 7 seconds/Probe after 4 mins





# Infrared Thermometers

## 422 Gun-style Infrared with Laser Sighting



(D:S)  
12:1

### Emissivity

is a measure of the efficiency in which a surface emits thermal energy. It is defined as the fraction of energy being emitted relative to that emitted by a thermally black surface (a black body). A black body is a material that is a perfect emitter of heat energy and has an emissivity value of 1.

## 423 Gun-style Infrared with Laser Sighting

Accepts Type K Thermocouple probes



(D:S)  
16:1

### D:S (Distance to Spot Ratio)

The further away from the object, the larger the surface area measured. Optical resolution is expressed as a ratio of the distance to the resolution spot divided by the diameter of the spot.

	422	423	424	425
<b>Temperature Range:</b>	-76° to 932°F (-60° to 500°C)	-76° to 1157°F (-60° to 625°C)	-76° to 1600°F (-60° to 900°C)	-76° to 1832°F (-60° to 1000°C)
<b>Accuracy:</b>	±4°F (±2°C)	±4°F (±2°C)	±4°F (±2°C)	±4°F (±2°C)
<b>Resolution:</b>	0.1°	0.1°	0.1°	0.1°
<b>Ambient Operating Range:</b>	32° to 122°F (0° to 50°C)	32° to 122°F (0° to 50°C)	32° to 122°F (0° to 50°C)	32° to 122°F (0° to 50°C)
<b>Laser:</b>	8-point	8-point	Dual Dot	Dual Dot
<b>Distance to Spot (D:S):</b>	12:1	16:1	35:1	50:1
<b>Emissivity:</b>	0.95 Fixed	Default 0.95 - adjustable from 0.10 to 1.00	Default 0.95 - adjustable from 0.10 to 1.00	Default 0.95 - adjustable from 0.10 to 1.00
<b>Storage Temperature:</b>	-4° to 149°F (-20° to 65°C) (without battery)	-4° to 149°F (-20° to 65°C) (without battery)	-4° to 149°F (-20° to 65°C) (without battery)	-4° to 149°F (-20° to 65°C) (without battery)
<b>Power:</b>	(2) 1.5V AAA (included)	(2) 1.5V AAA (included)	(2) 1.5V AAA (included)	(2) 1.5V AAA (included)
<b>Dimensions:</b>	1.625" x 5.5" x 7.25" (41 mm x 140 mm x 184 mm)	1.625" x 5.5" x 7.25" (41 mm x 140 mm x 184 mm)	7.75" x 1.875" x 8" (197 mm x 48 mm x 203 mm)	7.75" x 1.875" x 8" (197 mm x 48 mm x 203 mm)
<b>Battery Life:</b>	18 hrs typical/14 hrs continuous use with laser/backlight on	18 hrs typical/14 hrs continuous use with laser/backlight on	14 hrs typical/10 hrs continuous use with laser/backlight on	14 hrs typical/10 hrs continuous use with laser/backlight on
<b>Weight:</b>	8 oz (227 g)	9 oz (229 g)	1 lb (454 g) w/ stand	1 lb (454 g) w/ stand
<b>Regulatory Listings:</b>	CE RoHS	CE RoHS	CE RoHS	CE RoHS
<b>Warranty:</b>	1 year	1 year	1 year	1 year

## 424 Gun-style Infrared with Laser Sighting

- Measures min, max, average & differential temperatures
- Programmable HI/LO alarms
- Built-in, high-intensity LED flashlight
- Magnetic stand
- ABS carrying case



(D:S)  
35:1

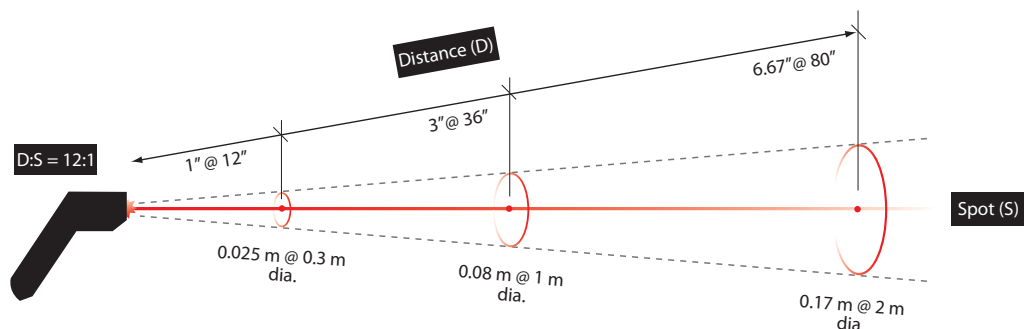

# Refrigerator/Freezer Thermometers



	25HP	330	335	535	2560
<b>Temperature Range:</b>	-20° to 80°F (-29° to 27°C)	-40° to 120°F (-40° to 50°C)	-40° to 80°F (-40° to 25°C)	-20° to 120°F (-30° to 50°C)	-22° to 122°F (-30° to 50°C)
<b>Accuracy:</b>	±2°F (±1°C)	±2°F (±1°C)	±2°F (±1°C)	±5°F (±2°C)	±1°F (±0.5°C)
<b>Housing Material:</b>	Stainless Steel	Food Grade Plastic	Stainless Steel	Plastic	Food Grade Plastic
<b>Dimensions:</b>	2.375" x 1.5" x 3" (60 mm x 38 mm x 76 mm)	0.625" x 0.25" x 4" (16 mm x 6 mm x 102 mm)	4.75" x 0.875" x 1.125" (120 mm x 22 mm x 29 mm)	2" (50.8 mm)	3.56" x 1.25" x 3.5" (90 mm x 32 mm x 89 mm)
<b>Lens Material:</b>	Glass	Food Grade Plastic	Food Grade Crystal Clear Polycarbonate	Plastic	Food Grade Polycarbonate
<b>Weight:</b>	1.5 oz (43 g)	.25 oz (7 g)	1 oz (28 g)	.5 oz (14 g)	1.5 oz (43 g)
<b>Regulatory Listings:</b>	NSF	NSF COMPONENT	NSF	-	CE NSF RoHS
<b>Warranty:</b>	1 Year	1 Year	1 Year	1 Year	Lifetime

## 330 Vertical Glass Tube Thermometer

- Lightweight design
- Durable, plastic casing
- Non-toxic, spirit-filled glass tube



## 335 Horizontal Glass Tube Thermometer

- Magnifying lens
- Hangs, stands or permanently mounts



## 25HP Refrigerator/Freezer Thermometer

- Includes dry storage range
- Hangs or stands



## 2560 Digital Refrigerator/Freezer Thermometer

- Guaranteed Accurate for Life!
- Hangs, stands, or mounts with cable ties
- Large, easy to read display
- Anti-microbial additive
- Removable plastic frame

# Hot-Holding Thermometers

	24HP	26HP	3210
<b>Temperature Range:</b>	100° to 600°F (50° to 300°C)	100° to 175°F (40° to 80°C)	100° to 600°F (50° to 300°C)
<b>Accuracy:</b>	±25°F (±12.5°C)	±3°F (±1.5°C)	±25°F (±12°C)
<b>Housing Material:</b>	Stainless Steel	Stainless Steel	Aluminum
<b>Dial Diameter:</b>	2" (51 mm)	2" (51 mm)	2.5" (64 mm)
<b>Lens Material:</b>	Glass	Glass	Glass
<b>Weight:</b>	1.5 oz (43 g)	1.5 oz (43 g)	3 oz (85 g)
<b>Regulatory Listings:</b>	NSF	NSF	NSF
<b>Warranty:</b>	1 Year	1 Year	1 Year



## 24HP Oven Thermometer

- HACCP zoned dial
- Hangs or stands

## 3210 Grill Surface Thermometer

- HACCP zoned dial
- Unique side grips



## 26HP Hot-holding Cabinet Thermometer

- HACCP Zoned dial
- Hangs or stands

# Digital Wall Thermometers

	TRH122M	TRH158	T158	IO70
<b>Temperature Range:</b>	14° to 122°F (-10° to 50°C) 10% to 99% RH	32° to 122°F (0° to 50°C) 25% to 90% RH	Internal: 32° to 122°F (0° to 50°C) External: -58° to 158°F (-50° to 70°C)	Internal: 32° to 122°F (0° to 50°C) External: -58° to 158°F (-50° to 70°C)
<b>Accuracy:</b>	±2°F (±1°C)	±2°F (±1°C) +5% RH	±2°F (±1°C)	±2°F
<b>Resolution:</b>	0.1°	0.1°	0.1°	0.1°
<b>Display - LCD</b>	1.5" x 0.5" (38 mm x 13 mm) (dual display)	2.875" x 2.125" (73 mm x 54 mm)	2.875" x 2.125" (73 mm x 54 mm)	1.625" x 1.375" (41 mm x 35 mm)
<b>Power:</b>	(1) 1.5V Battery AAA	(1) 1.5V Battery AAA	(1) 1.5V Battery AAA	(1) 1.5V Battery AAA
<b>Weight:</b>	3 oz (85 g)	4.5 oz (127 g)	5.5 oz (156 g)	3 oz (85 g)
<b>Regulatory Listings:</b>	CE RoHS	CE RoHS	CE RoHS	-
<b>Warranty:</b>	1 Year	1 Year	1 Year	1 Year



**TRH158**  
**Digital Temperature/Humidity Wall Thermometer**  
 • Built-in sensor  
 • °F/°C selectable



**TRH122M**  
**Mini Temperature/Humidity Dual-Display Wall Thermometer**  
 • Min/Max memory and switchable °F / °C



**IO70**  
**Digital Indoor/Outdoor Wall Thermometer**  
 • Large LCD  
 • Built-in sensor  
 • 10' cable for remote sensor



**T158**  
**Digital Wall Thermometer with Remote Sensor**  
 • Wall or desk mountable  
 • Remote sensor  
 • °F/°C selectable  
 • 10' cable

# Wall Thermometers

Please refer to product specs on page 30



**250**  
**5" Wall/Storage Thermometer**



**255-14**  
**6" Refrigerator/Freezer Thermometer**



**255-06**  
**6" Wall/Storage Thermometer**



# Wall Thermometers

**Wall Thermometers/Hygrometers** allow easy monitoring of temperatures. Specialty HACCP color-zoned dial units were developed for use in critical food-related applications. These thermometers have large numbers and oversized dials for easy viewing.

## 212 Series

## 250/255 Series

	212-150	212-158	212-159	250	255-06	255-14	268
<b>Temperature Range:</b>	-40° to 120°F (-40° to 50°C) 0 to 100% RH	10° to 80°F 0 to 100% RH	-10° to 80°F 0 to 100% RH	-40° to 120°F (-40° to 50°C)	-60° to 120°F (-50° to 50°C)	-10° to 80°F	-40° to 120°F (-50° to 50°C)
<b>Accuracy:</b>	±3°F (±1.5°C)	±3°F	±3°F	±2°F (1°C)	±2°F (1°C)	±2°F (1°C)	±2°F (1°C)
<b>Resolution:</b>	2°F increments	1°F increments	2°F increments	±2°F (1°C)	2°F increments	2°F increments	2°F increments
<b>Dial Diameter:</b>	11.5" (291 mm)	11.5" (291 mm)	11.5" (291 mm)	4.5" (114 mm)	6" (152 mm)	6" (152 mm)	-
<b>Weight:</b>	1 lb (454 g)	1 lb (454 g)	1 lb (454 g)	4 oz (113 g)	3 oz (85 g)	3 oz (85 g)	2 oz (57 g)
<b>Warranty:</b>	1 year	1 year	1 year	1 year	1 year	1 year	1 year



**212-150**  
12" Wall Thermometer/Hygrometer



**268**  
Wall Thermometer  

- Non-toxic, spirit-filled glass tube
- Suction cups included for window mounting
- 1-year warranty



**212-158**  
12" Prep & Dry Storage  
Thermometer/Hygrometer (°F)  





- HACCP colored-zone dial



**212-159**  
12" Freezer & Cooler  
Thermometer/Hygrometer (°F)  

- HACCP colored-zone dial

# Timers

	FT24	TC6	TFS4	TM60	TS100	TW3
<b>Unit Range:</b>	23:59:59 Hours	23:59:59 Hours	99 Hours, 59 Minutes	0 to 60 Minutes	99 Minutes, 59 seconds	99 Minutes, 59 seconds
<b>Resolution:</b>	1 second	1 second	Hours/Minutes Minutes/Seconds	1 minute	1 second	1 second
<b>Power Source:</b>	(4) 1.5v C	1.5 v AAA	(4) 1.5v C AC Adaptor (optional)	Wind up	1.5v LR44	1.5 v AAA
<b>Memory / Recall:</b>	Yes	Yes	Yes	No	Yes	Yes
<b>Modes:</b>	-	Counts up/down	Counts up/down	-	-	-
<b>Alarm Level (Decibel):</b>	90 decibels	85 decibels	90 decibels	70 decibels	70 decibels	70 decibels
<b>Housing:</b>	ABS Plastic	White plastic	ABS plastic	Stainless steel	ABS plastic	ABS plastic
<b>LCD Dimensions:</b>	0.875" x 2.25" (22 mm x 54 mm)	0.625" x 1.625" (16 mm x 41 mm)	3" x 3" (76 mm x 76 mm)	-	0.375" x 0.875" (10 mm x 22 mm)	1.5" x 2.5" (76 mm x 64 mm)
<b>Weight:</b>	1 lb 3 oz (539 g)	2 oz (57 g)	1 lb 6oz (523 g)	4.3 oz (122 g)	1 oz (28 g)	3 oz (85 g)
<b>Regulatory Listings:</b>	CE 	CE  RoHS	CE  RoHS	-	CE  RoHS	CE  RoHS
<b>Warranty:</b>	2 Years	1 Year	1 Year	1 Year	1 Year	1 Year



- TC6**  
**Digital Timer/Clock/Stopwatch**
- Built-in memory
  - Splash proof case
  - Wire hang, easel stand, clip-on or magnet-mount
  - Power: 1.5V, AAA battery included

**FT24**  
**Large Single-Station Digital Timer**

- Red light flashes when alarm sounds
- Built-in memory for repeat cycle timing
- Power: (4) 1.5V, C size batteries included



**TFS4**  
**Large Multi-Station Digital Timer**

- Switchable: Hours/Minutes or Minutes/Seconds
- Built-in Memory
- Power: (4) 1.5V, C size batteries included
- Built-in AC adapter jack



**TS100**  
**Digital Timer/Stopwatch**

- 99 minute, 59 second counter/timer
- Recall feature
- 18" nylon neck cord
- Power: 1.5V, G13A micro-cell battery included



**TM60**  
**Long-Ring 60 Minute Timer**

- Non-skid feet for easy, one-handed operation
- Spring-wound mechanism
- Sturdy, Stainless Steel case



**TW3**  
**Large Digit Multi-Function Timer**

- Recall feature
- Water resistant
- Large LCD: 1.5" x 2.5" (38 mm x 63 mm)
- Power: 1.5V, AAA battery included
- Wire hang, easel stand, belt-clip or magnet-mount



Proud Members of:

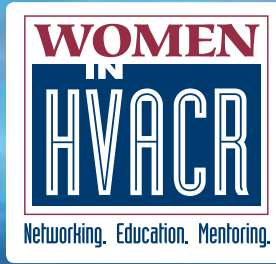

To request a free copy of any promotional materials contact:

**Cooper-Atkins Corporation**  
33 Reeds Gap Road • Middlefield, CT 06455-0450 U.S.A.  
860-347-2256 • Fax: 860-347-5135 • [www.cooper-atkins.com](http://www.cooper-atkins.com)